

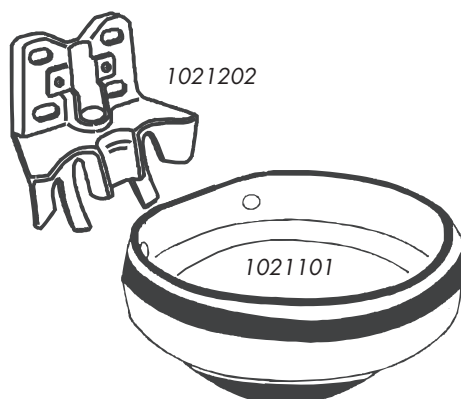

52405

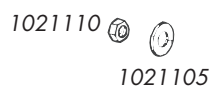

mécanisme complet

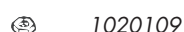
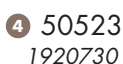
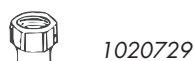
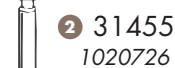
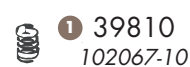
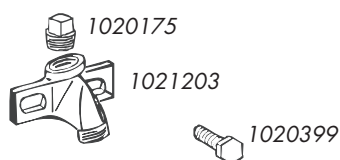
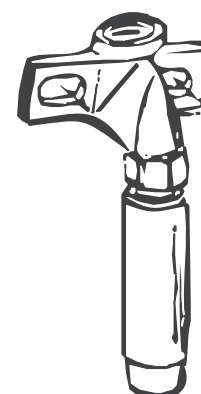
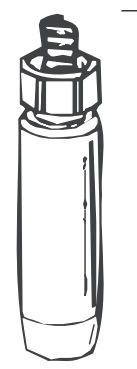

Disponible sur stock

Pièces détachées 1200

| | | Condi | Réf. |
|---|---------------------------|-----------|----------|
| 1 | RESSORT SOUPAPE | 102067-10 | 10 39810 |
| 2 | LEVIER INOX S.96 | 1920730 | 4 31455 |
| 3 | JOINT SOUP.94.95.M20 | 1990727 | 10 31471 |
| 4 | LEVIER TUBULAIRE PLAST. | 1920730 | 4 50523 |
| 5 | ENSEMBLE INF. ROBINET 25R | 1920759 | 2 65551 |

Les références ci-dessus correspondent aux pièces d'usures courantes.
Si vous souhaitez une pièce non stockée, contactez notre service commercial.